

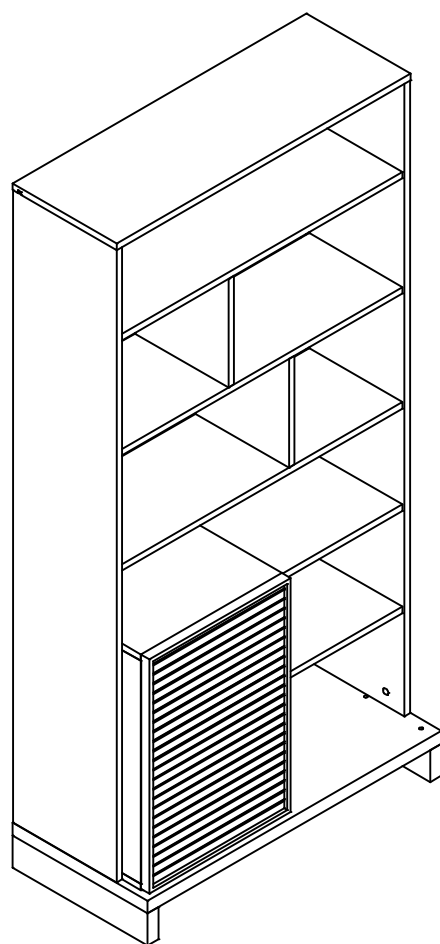

# NUM-10

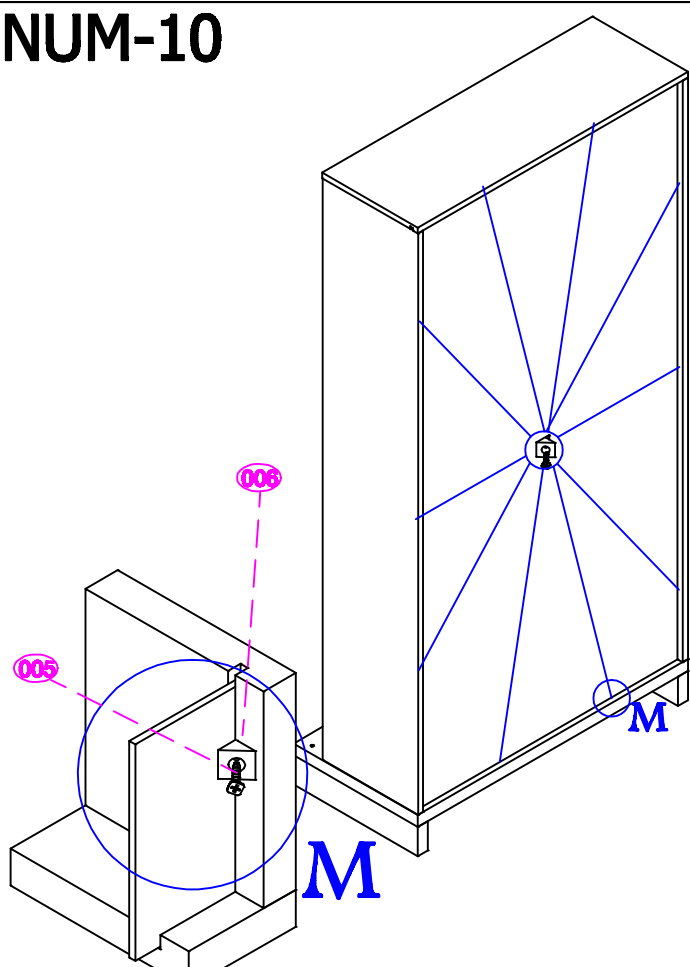
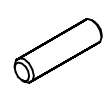

**001**  
QTY:18  
  
102 130 201

**002**  
QTY:26  
  
102 180 102

**003**  
QTY:24  
  
102 120 202

**004**  
QTY:12  
  
101 020 201

**005**  
QTY:10  
  
101 020 114

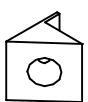
**006**  
QTY:10  
  
102 170 102

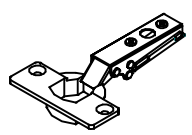
**007**  
QTY:2  
  
102 010 105

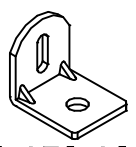
**008**  
QTY:2  
  
102 150 103

**009**  
QTY:6  
  
101 010 241

**010**  
QTY:2  
  
101 010 225